

SÈRIE 1

S1.1A

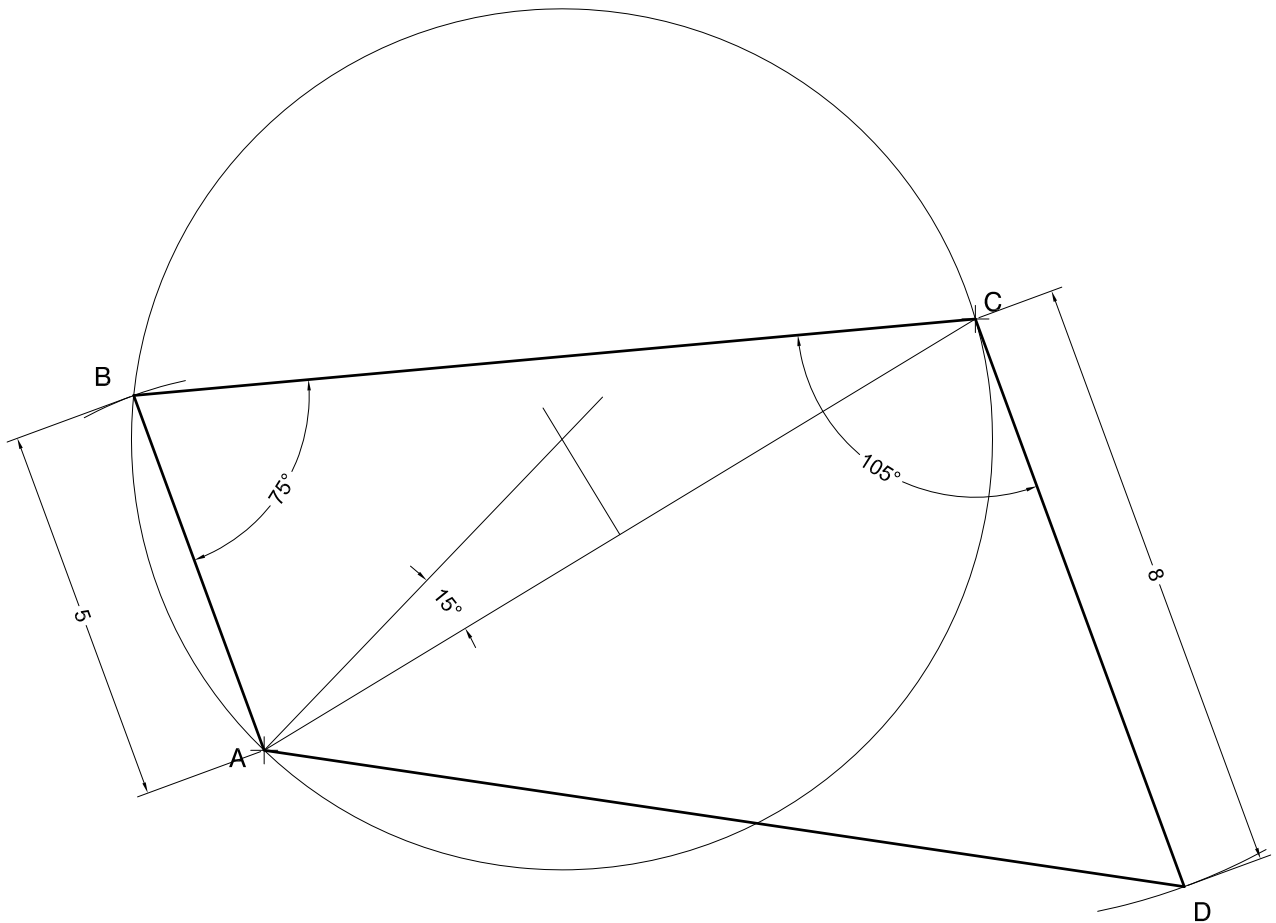
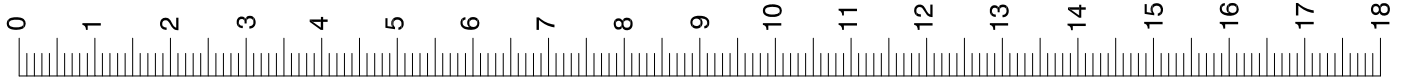

$ABC = 75^\circ$
 $BCD = 105^\circ$
 $CD = 8$
 $AB = 5$

8,25 metres

S1.1B

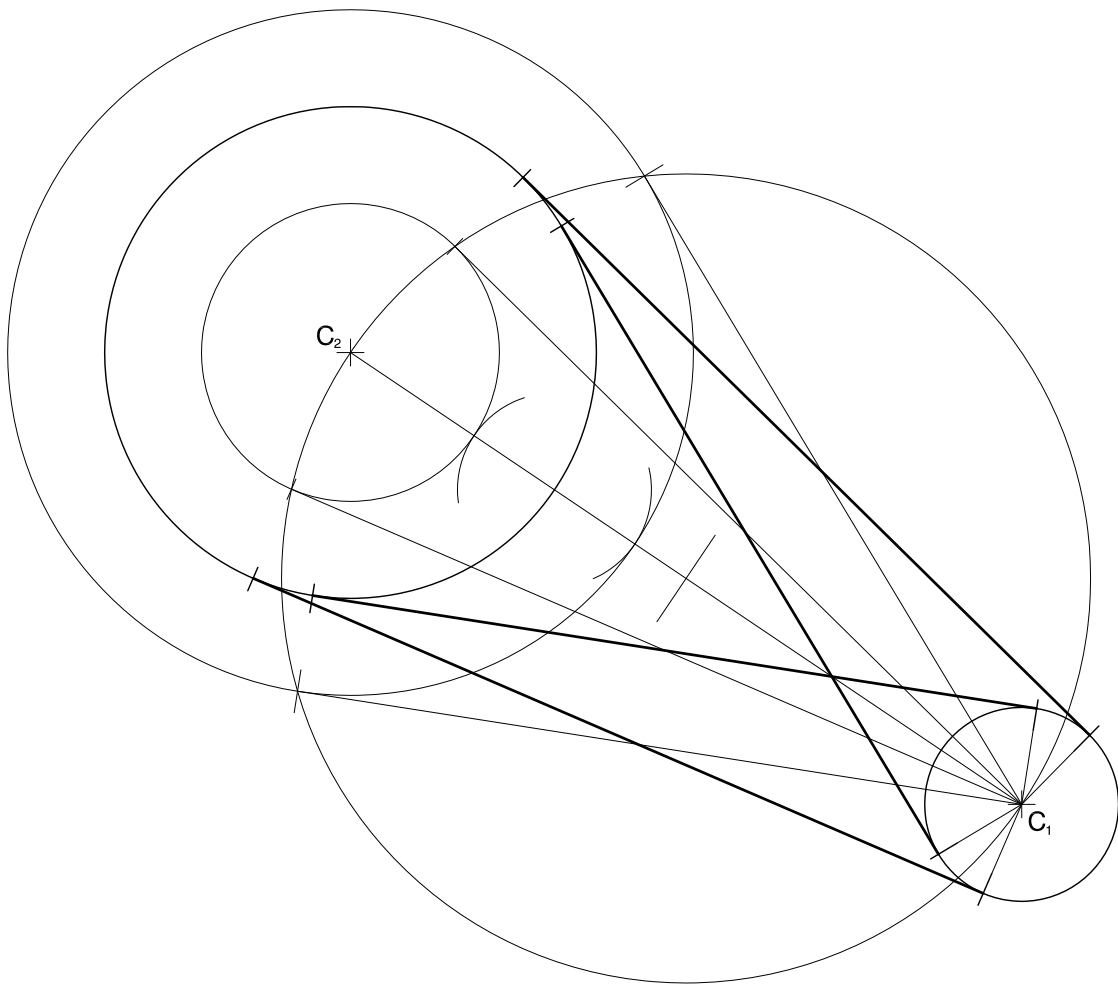
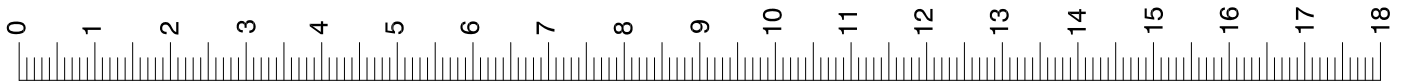

S1.2A

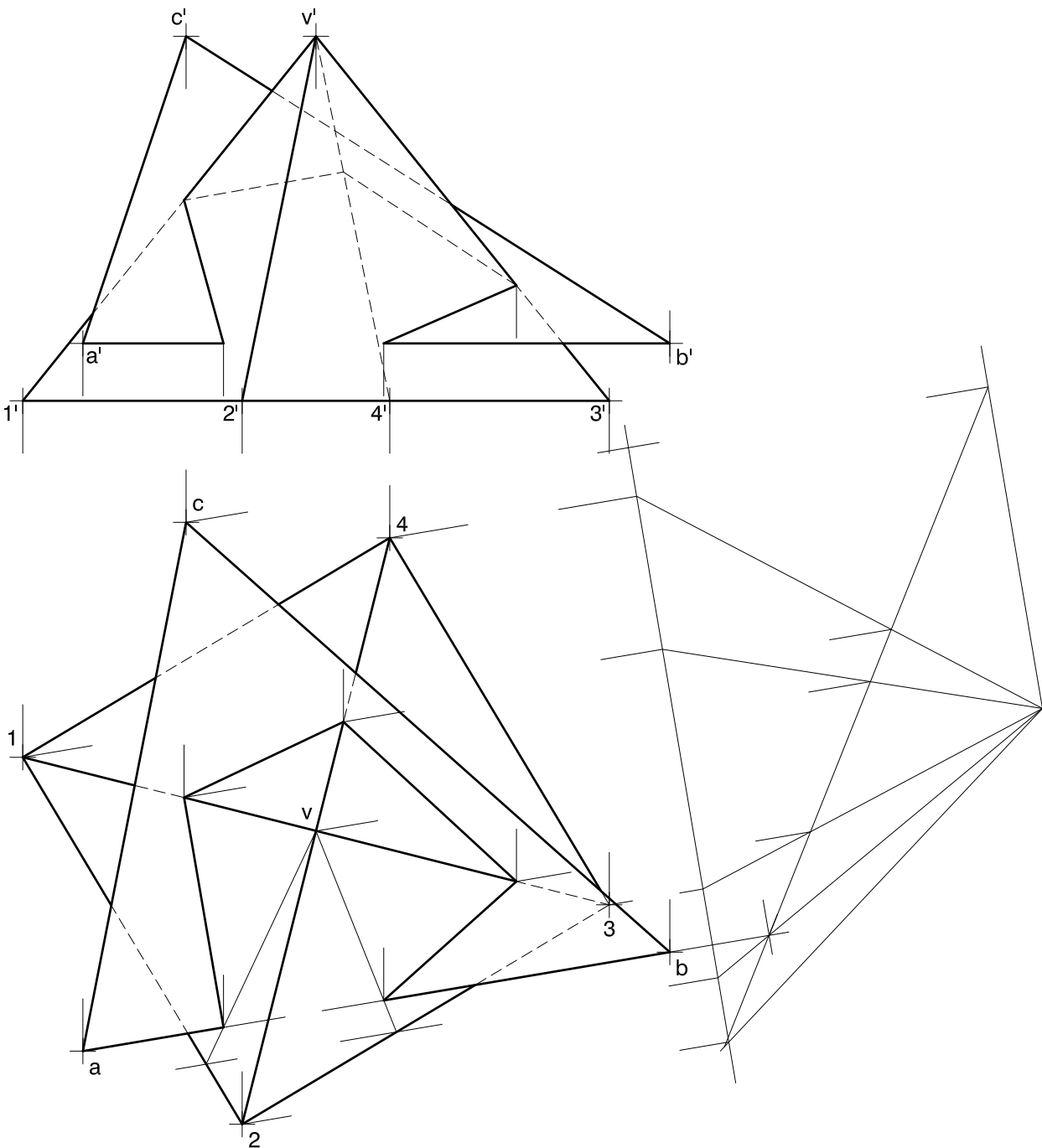

S1.2B

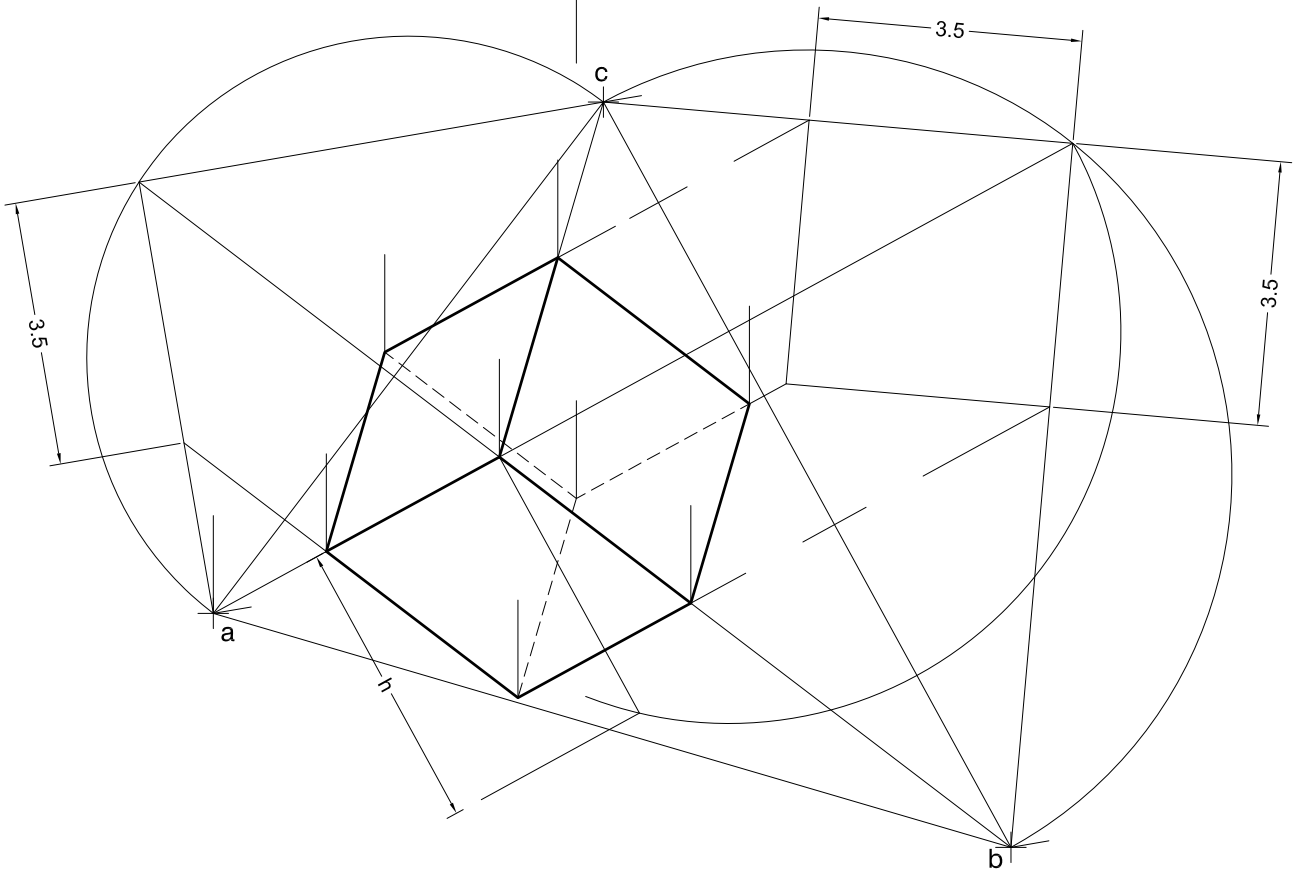
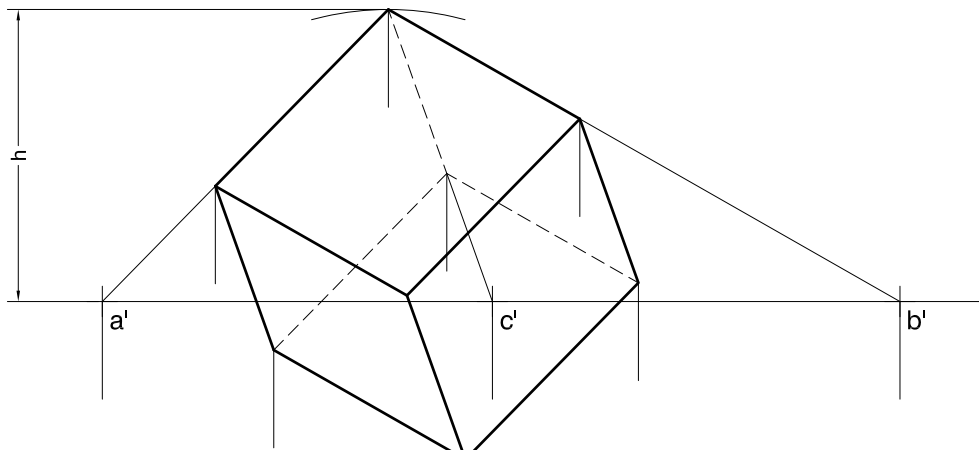
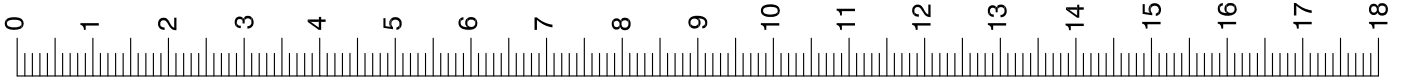

S1.3A

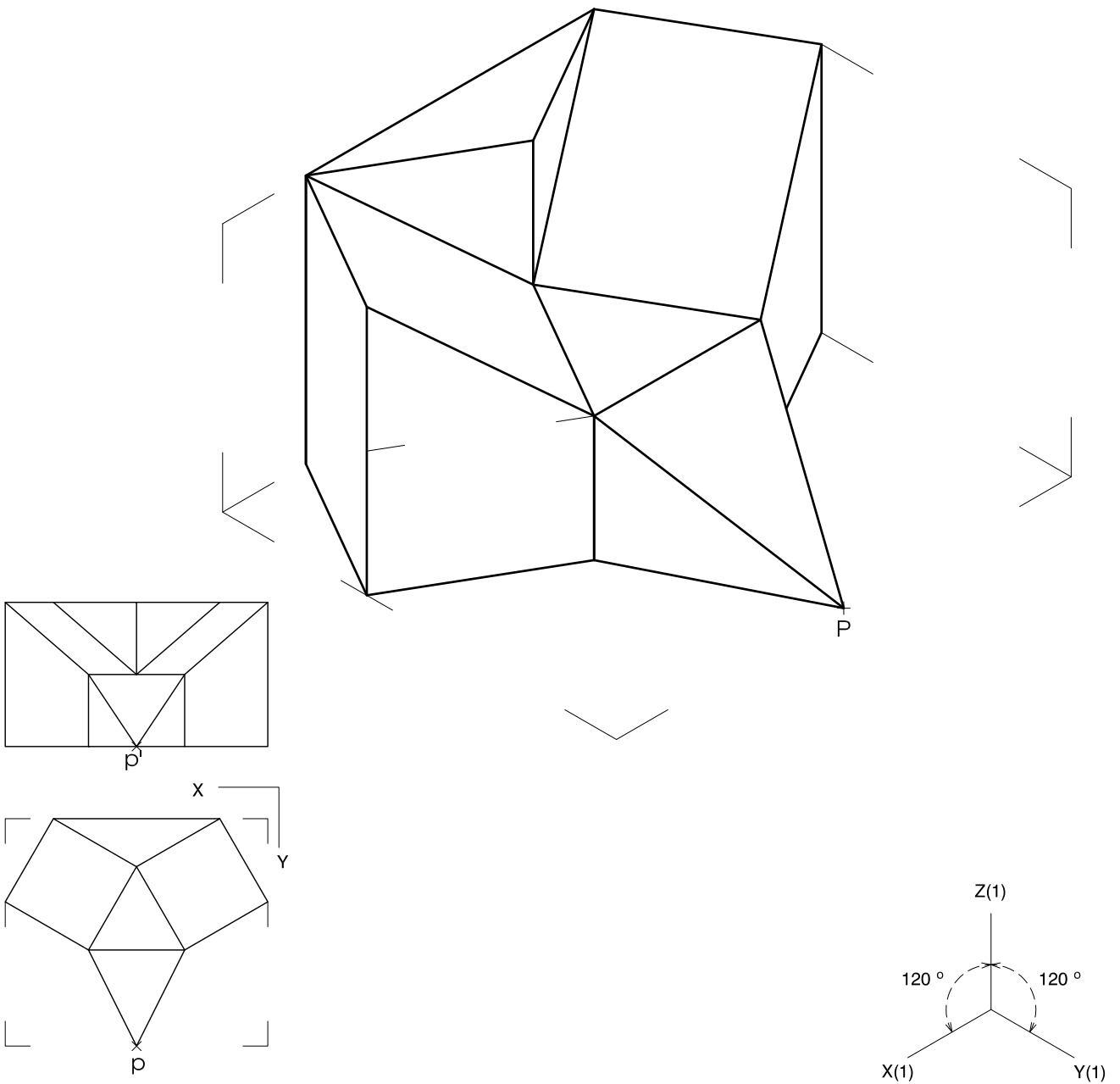
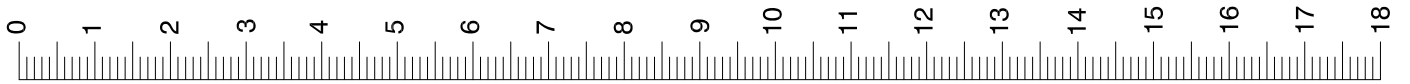

S1.3B

